

Article number: 435700020

Description: Rota-fix shaft-hub connection K 20x38

Note: Self centering. Medium torque

Measures

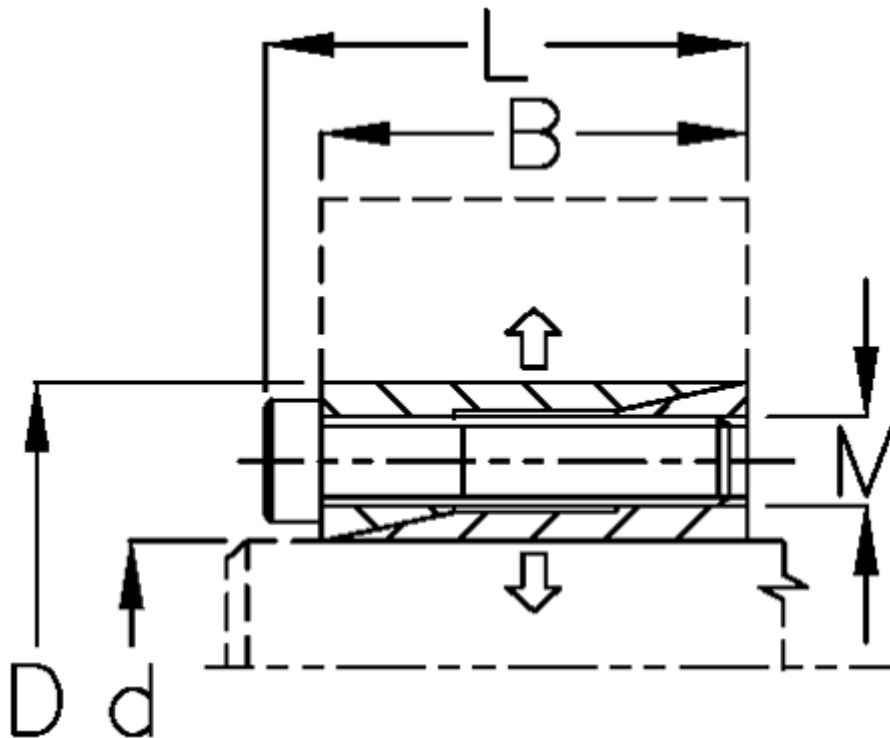

B mm	= 21
d mm	= 20.00
D mm	= 38
Fit tolerance	= Aksel h8, Nav H8
F kN torque	= 15.0
L mm	= 26.0
M mm	= M5
P N/mm ² surface pressure on shaft/hub	= 75

Surface roughness	= R? ? 3.2 µm
T N m torque	= 150
Ts N m bolt tightening torque	= 9.7